

Recommended glass thickness 6-10mm

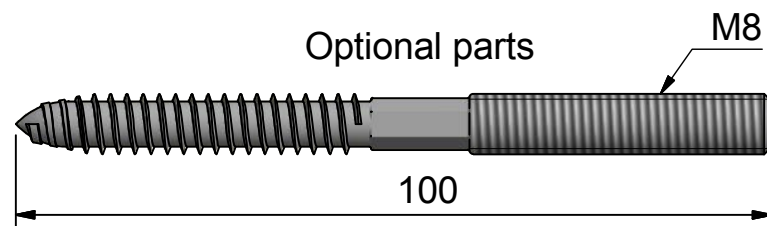

RG-183 / 861558

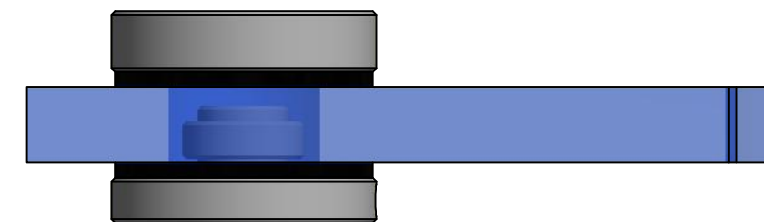
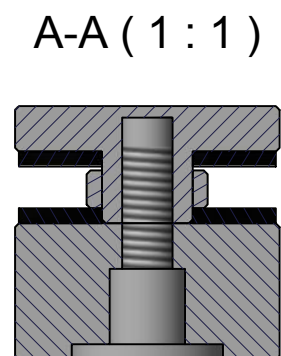
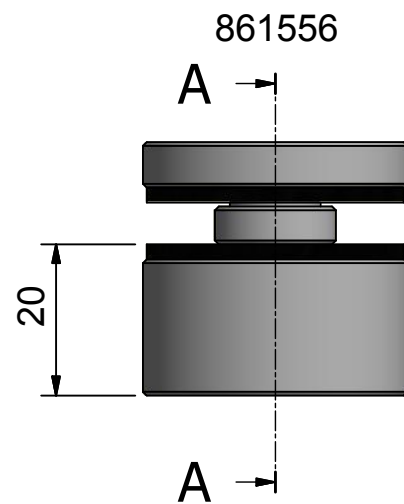
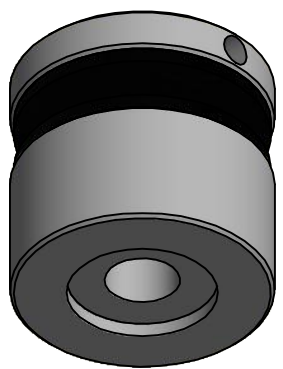
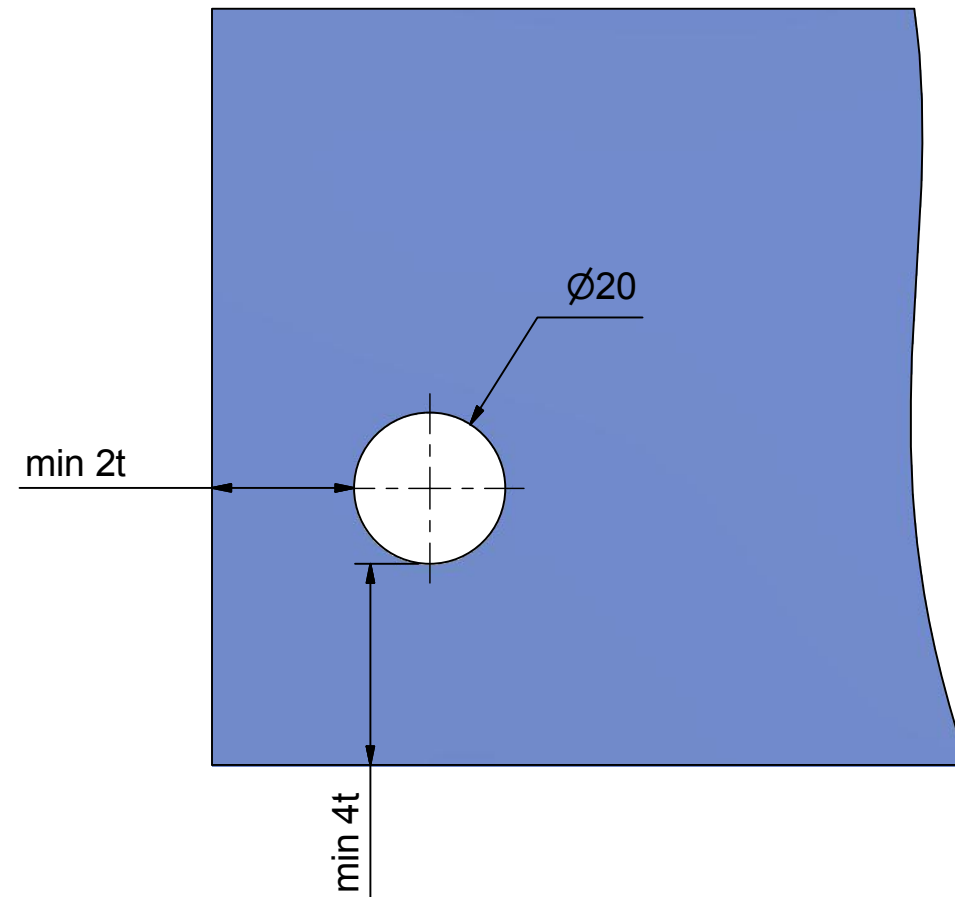
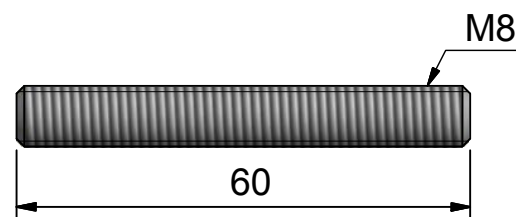

RG-184 / 861559

t=glass thickness

Date		V2 160516/AG
Name	Single fixing point Ø35	Item no.
		RG-182